

Астана +7(77172)727-132 Волгоград (844)278-03-48 Воронеж (473)204-51-73
Екатеринбург (343)384-55-89 Казань (843)206-01-48 Краснодар (861)203-40-90
Красноярск (391)204-63-61 Москва (495)268-04-70 Нижний Новгород (831)429-08-12
Новосибирск (383)227-86-73 Ростов-на-Дону (863)308-18-15 Самара (846)206-03-16
Санкт-Петербург (812)309-46-40 Саратов (845)249-38-78 Уфа (347)229-48-12
Единый адрес: alg@nt-rt.ru Веб-сайт: aalborg.nt-rt.ru

Technical Data Sheet No.: TD-TPU-TPV-11-12 Rev. B

Date of Issue: April 2013

OPERATING MANUAL

Aalborg® TPU and TPV Peristaltic Pumps



Aalborg[®] is a registered trademark of Aalborg Instruments & Controls.

Hypalon[®] is a registered trademark of DuPont Performance Elastomers, LLC.

Norprene[®] is a registered trademark of Saint-Gobain Abrasives, Inc.

PharMed[®] and Tygon[®] are registered trademarks of Saint-Gobain Performance Plastics.

NOTE: Aalborg reserves the right to change designs and dimensions at its sole discretion at any time without notice. For certified dimensions, please contact Aalborg[®].

TABLE OF CONTENTS

1.	GENERAL INFORMATION.....	4
1.1	General.....	4
1.2	Principles of Operation.....	4
1.2.1	TPU Models.....	5
1.2.2	TPV Models.....	6
1.2.3	TP1 & TP3 Pump Head Models.....	6
2.	UNPACKING THE PUMP.....	7
2.1	Inspect Package for Shipping Damage.....	7
2.2	Unpack Your Order.....	7
3.	PREPARATION & INSTALLATION.....	8
3.1	Installing Tubing in a TPU Pump.....	8
3.2	Installing Tubing in a TPV Pump.....	12
3.3	Installing the Pump.....	17
4.	SPECIFICATIONS.....	18
5.	OPERATING INSTRUCTIONS.....	19
5.1	Powering On.....	19
5.2	Priming the Pump.....	19
5.3	Programming the TPUDP MUR3 Timer (if present).....	20
5.4	Programming the TPURP MLR1 Timer (if present).....	23
6.	MAINTENANCE.....	25
7.	TROUBLESHOOTING.....	26
8.	STORAGE.....	27
9.	RETURN.....	28
10.	ABBREVIATIONS.....	30
11.	WARRANTY.....	31

1. GENERAL INFORMATION

1.1 General

Aalborg's TPU and TPV model peristaltic pumps are designed for safety and long life. They are economical, easy to load, sturdy, and compact for a small footprint. Designed for use with liquids of widely diverse viscosity, they are suitable for laboratory, processing and OEM applications, even fuel with the appropriate tubing.



CAUTION: PERISTALTIC PUMPS, INCLUDING MODELS TPU AND TPV, ARE NOT SUITABLE FOR USE WITH BLOOD. THE ROLLER TECHNOLOGY CAN CAUSE HEMOLYSIS.

1.2 Principles of Operation

Flexible tubing, which conveys fluid from source to destination, is squeezed inside the pump head by rotating rollers against a rigid, crescent-shaped occlusion wall. The rollers induce suction in a pulsing rhythm. The occlusion is adjustable on TPU models for increased pressure, or decreased pressure to extend tubing life.

Each pump is comprised of a front panel with controls, a pump head, a motor, a rigid case with four rubber feet and a handle.

The handle is practical both to carry the pump and, when rotated beneath the pump, to serve as a base that lifts and angles the pump face, making the controls even more easily accessible to the user.

1.2.1 TPU Models

The TPU models are variable speed or fixed speed pumps. All versions have 4 rollers standard, with an option of 10 rollers.

- The fixed speed TPUFX, powered by an AC motor, is preset at the factory between 3 and 50 rpm, according to the customer's order.
- The variable speed TPUAD, TPUDP and TPURP models, powered by a brushless 24 V DC motor, can be user-set from 0 to 60 rpm. Pumping direction is reversible.

Figure 1: One Model TPU Pump: the TPUAD



1.2.2 TPV Models

The TPV models, which have a pump head with 3 rollers, are variable speed pumps, powered by a brushless 24 V DC motor, can be user-set from 0 to 300 rpm. Pumping direction is reversible.

Figure 2: One Model TPV Pump: the TPVAD

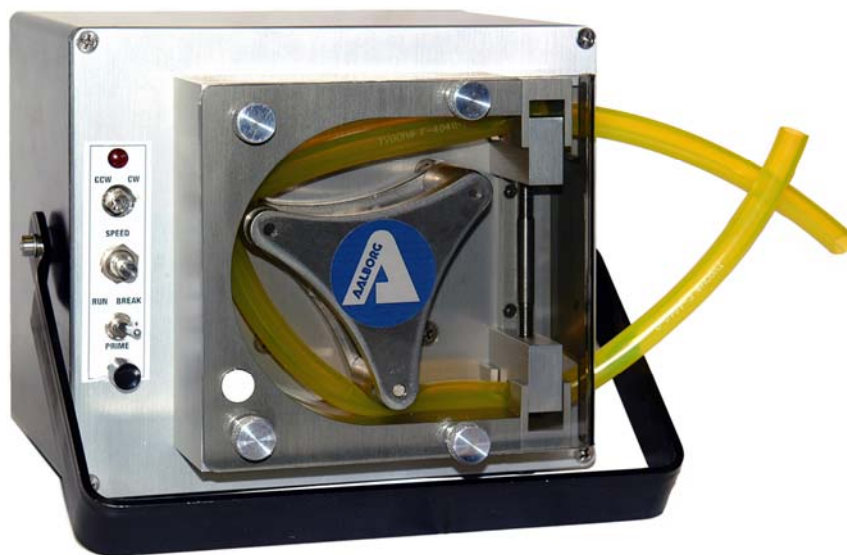

1.2.3 TP1 & TP2 Pump Head Models

The TP1 and TP2 models are stand alone pump heads with a safety cover. They are not equipped with control panel, motor or rigid case. The TP1 model has 4 rollers, while the TP2 model has 10 rollers.

2. UNPACKING THE PUMP

2.1 Inspect Package for Shipping Damage

Before you open the cardboard carton that contains your order, carefully inspect the outside for any external damage that may have occurred during shipping. If there is any damage, report it immediately to the shipping company.

2.2 Unpack Your Order

Carefully open the carton from the top. Save all packing materials for possible reuse for future storage or shipment.

If you find any shipping damage within the box, contact your shipping company and report the damage to your Aalborg[®] distributor or to Aalborg directly.

Using the packing list, verify that you have received your entire order. Promptly contact your Aalborg[®] distributor or Aalborg directly if anything is missing.

3. PREPARATION & INSTALLATION

3.1 Installing Tubing in a TPU Pump

If you have a TPV pump, skip to Section 3.2.

The pumps can take tubing of 1/8-, 3/16-, 1/4- and 5/16-inch inner diameter; all should have a wall thickness of 1/16 inch. Aalborg® recommends the use of the following flexible tubing: Tygon® 3603, peroxide-treated silicone, platinum-treated silicone, PharMed®, Norprene®, and Hypalon®.

Graphs 1 & 2 provide typical flow rates for TPU pumps with 4 or 10 rollers, using Tygon® laboratory tubing of various inside diameters:

GRAPH 1: TYPICAL TPU PUMP FLOW RATES (with 4 rollers)

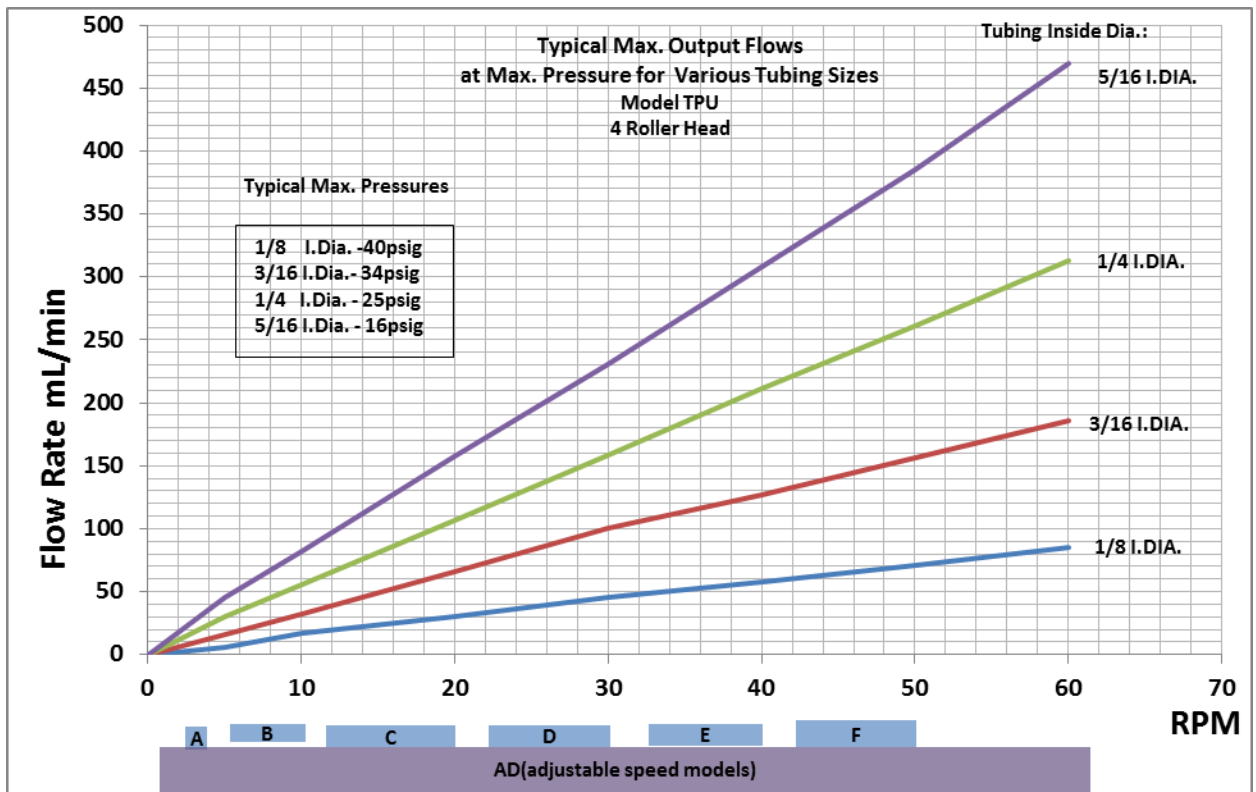

GRAPH 2: TYPICAL TPU PUMP FLOW RATES (with 10 rollers)

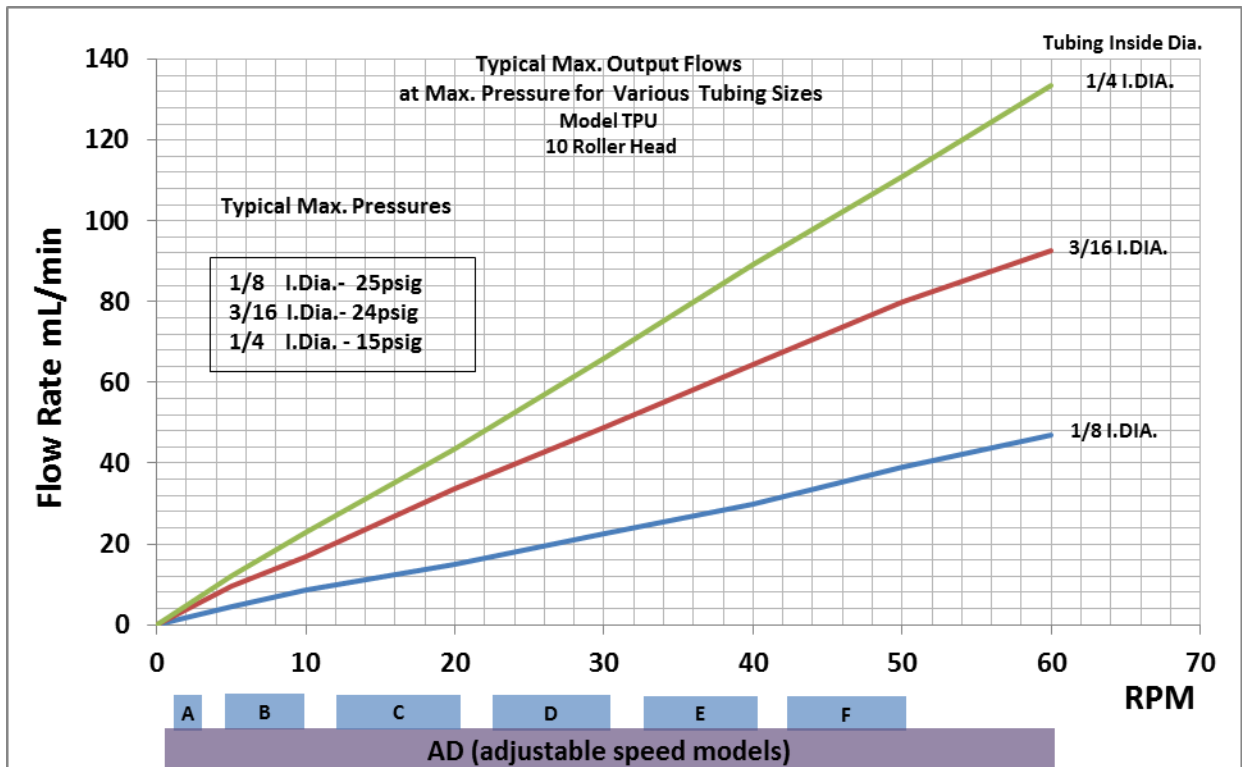

NOTE: Not all features are available on all TPU models. In particular, the speed adjustment knob and flow direction switch are not available on the fixed speed models.

Figure 3 calls out the primary user-interface features of a TPU pump.

FIGURE 3: TPU PUMP FEATURES (model shown is a TPUAD)

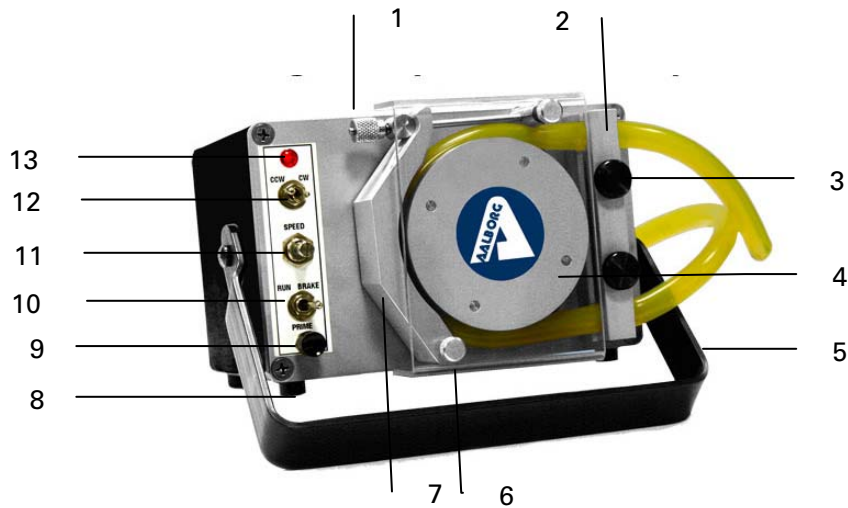

1	Occlusion clamp lever	8	Foot (1 of 4)
2	Tubing separator	9	Prime button
3	Thumbscrews for separator	10	Run/Brake (on/off) switch
4	Transparent safety cover	11	Pumping speed adjustment knob
5	Handle/base	12	Flow direction switch (CCW, counterclockwise/CW, clockwise)
6	Cover thumbscrew (1 of 2)		
7	Occlusion clamp	13	Run indicator light

To install tubing, with reference to Figure 3:



CAUTION: MAKE SURE THE PUMP IS TURNED OFF. BE CAREFUL NOT TO PINCH YOUR FINGERS.

1. Remove the 2 thumbscrews from the transparent safety cover, then lift the cover away from the pump face and set it aside.

2. Unscrew the thumbscrew at the end of the occlusion clamp lever until the lever is loose enough to move.
3. Move the occlusion clamp lever to release all pressure from the occlusion clamp, opening the tubing channel.
4. Loosen the 2 black thumbscrews on the tubing separator, until the separator is free.
5. Lift the separator straight away from the pump face and set it aside.
6. To load the tubing, lay the tubing in the pump channel around the pump head, turning the pump head by hand in either direction, with both ends of the tubing on the righthand side.
7. When the tubing is in place, reinstall the tubing separator, with each end cupping the tubing.
8. Finger tighten the black thumbscrews on the tubing separator until the separator fits snugly against the tubing . Make sure the tubing is immobilized but not pinched.
9. Snap the occlusion clamp lever back into place and tighten its thumbscrew until the occlusion clamp is appropriately tight.
10. Hold the safety cover in place as you reinstall both thumbscrews. Finger tighten the thumbscrews.



CAUTION: NEVER RUN THE PUMP WITHOUT THE SAFETY COVER IN PLACE.

3.2 Installing Tubing in a TPV Pump

The pumps can take tubing of 1/4-, 5/16-, 3/8-, 7/16- and 1/2- inch inner diameter; all should have a wall thickness of 1/16 inch.

Aalborg[®] recommends the use of the following flexible tubing: Tygon[®] 3603, peroxide-treated silicone, platinum-treated silicone, PharMed[®], Norprene[®], and Hypalon[®].

Graphs 3a & 3b provide typical flow rates for TPV pumps with 3 rollers, using Tygon[®] laboratory tubing of various inside diameters:

GRAPH 3a: TYPICAL TPV PUMP FLOW RATES
(1/4-, 5/16- & 3/8-inch inner diameter)

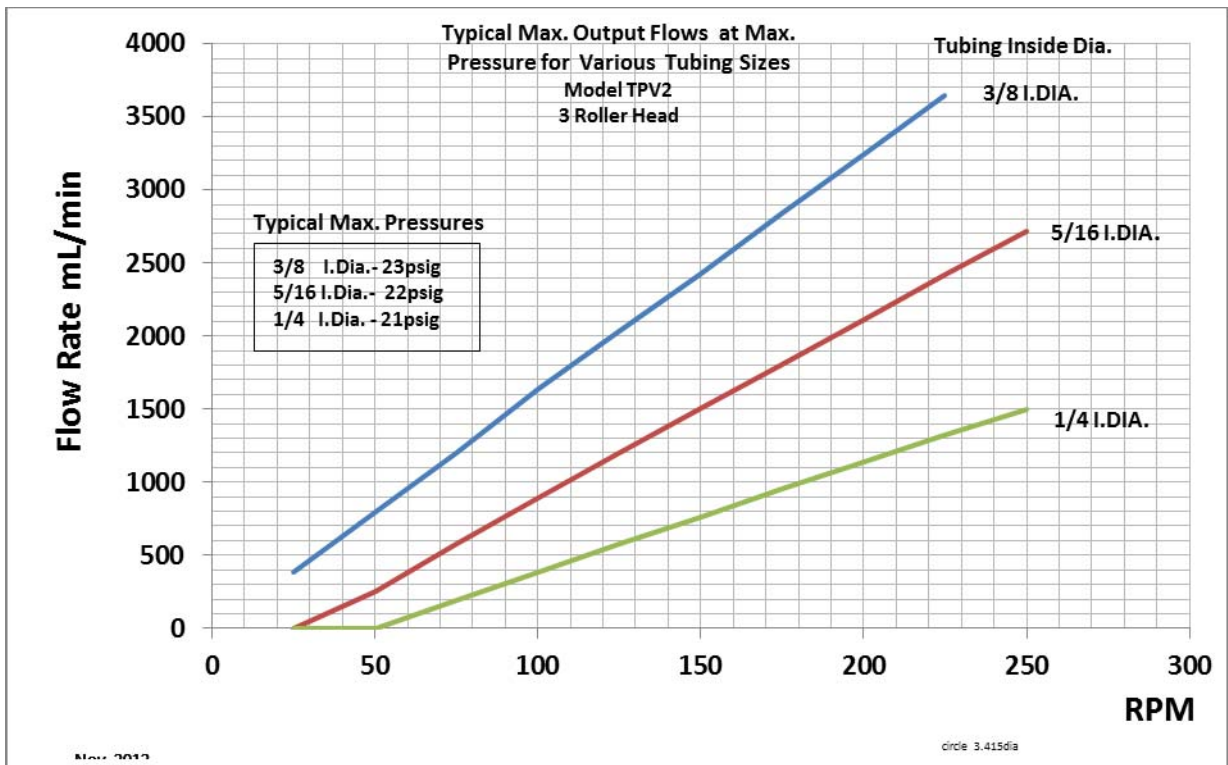

GRAPH 3b: TYPICAL TPV PUMP FLOW RATES (7/16- & 1/2-inch inner diameter)

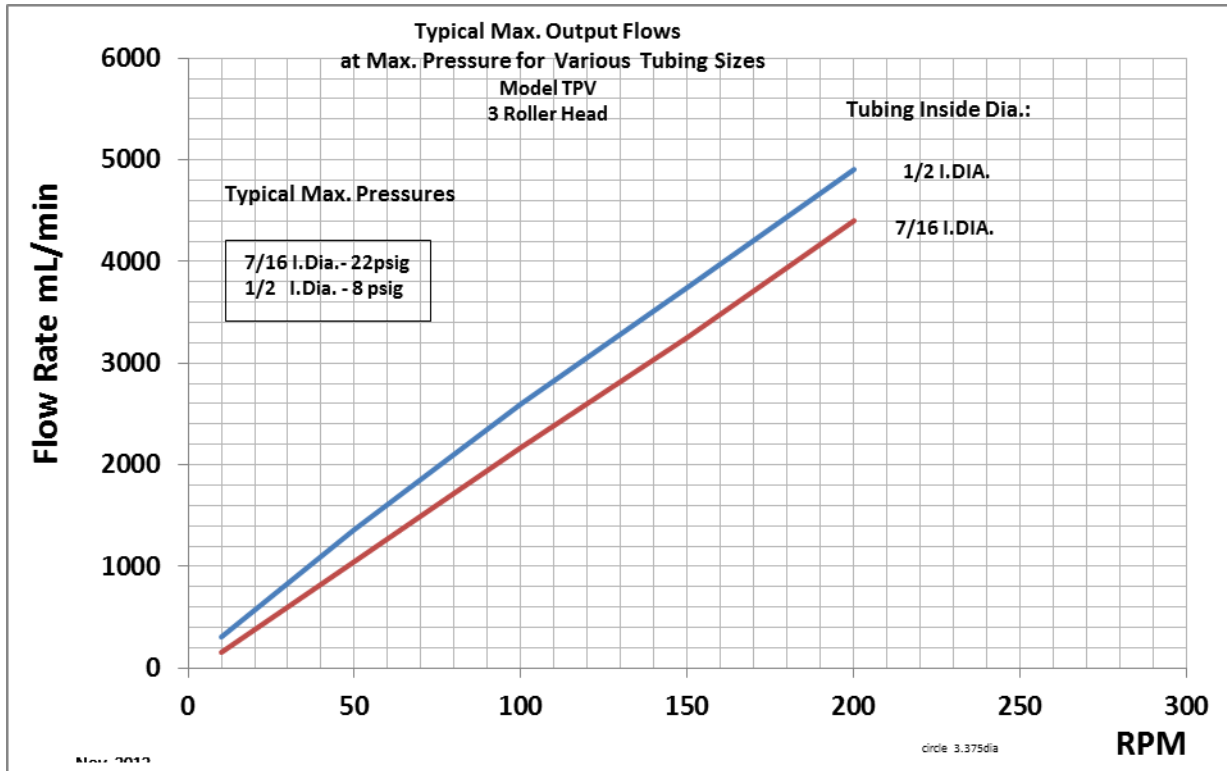
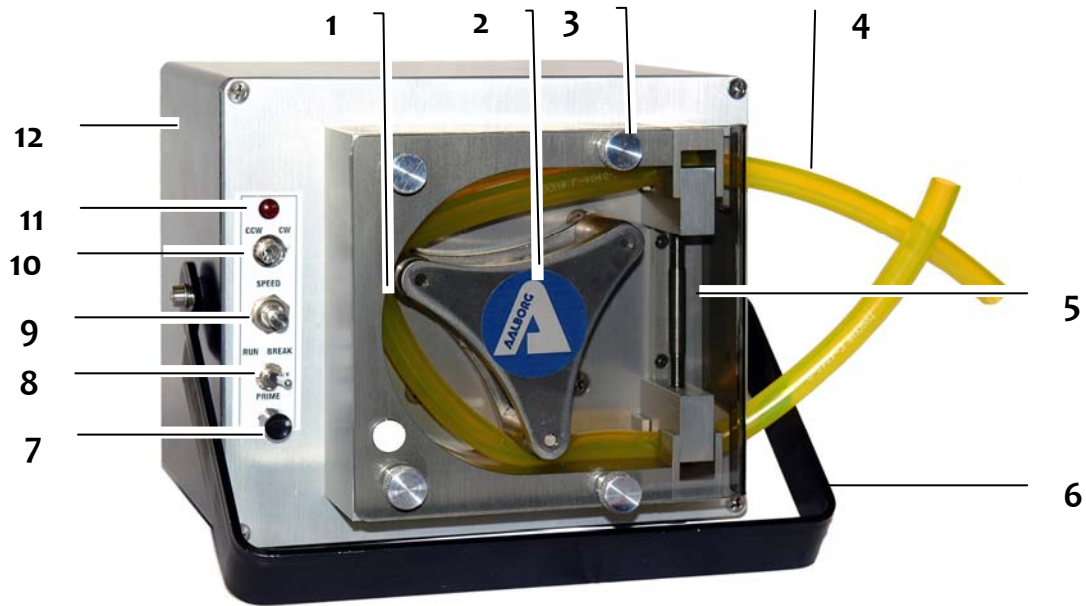

FIGURE 4: TPV PUMP FEATURES



1	Fixed occlusion wall	7	Prime button
2	Pump head (3 rollers)	8	Run/Brake (on/off) switch
3	Cover thumbscrew (1 of 4)	9	Pumping speed adjustment knob
4	Tubing	10	Flow direction switch
5	Adjustable tubing holder subassembly (see Figure 5)	11	Run indicator light
6	Handle/base	12	Rigid case

One special feature of the TPV pumps is the adjustable tubing holder subassembly, which functions like a turnbuckle to loosen the subassembly for removal and to tighten it for installation. The threading on both ends of its central rod allows you to independently adjust the pressure of each end block against the tubing.

When the subassembly is removed from the pump, each end block can be spun upward or downward independently on the turnbuckle. As shown in Figure 5, the end blocks are grooved on one side. These grooves fit onto the key ridge on the front plate in order to set the subassembly securely in place.

FIGURE 5: ADJUSTABLE TUBING HOLDER SUBASSEMBLY

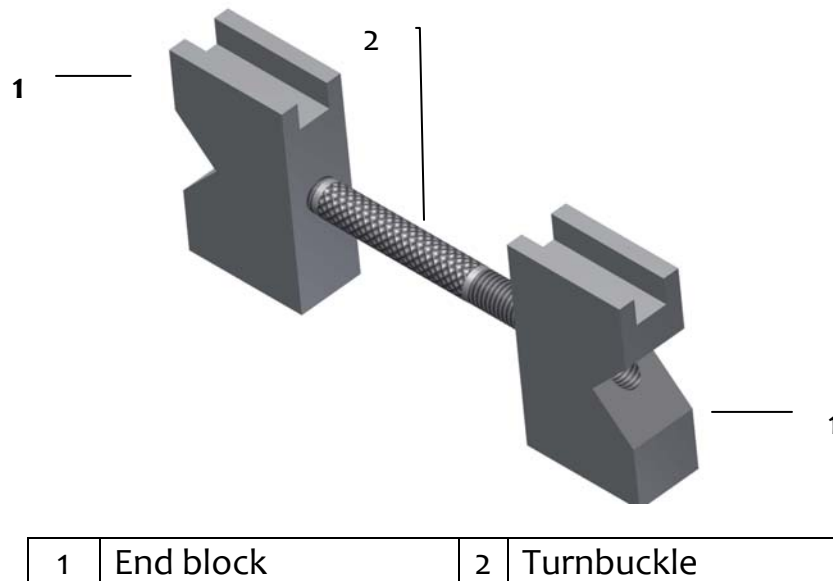

NOTE: Each end block can be raised or lowered independently on the rod, to suit the need for the pressure on the tubing at either ends.

To install tubing, with reference to Figures 4 & 5:



CAUTION: MAKE SURE THE PUMP IS TURNED OFF. BE CAREFUL NOT TO PINCH YOUR FINGERS.

1. Remove the 4 thumbscrews from the transparent safety cover, then lift the cover away from the pump face and set it aside.
2. Loosen the turnbuckle rod between the top and bottom parts of the tubing holder subassembly, until the subassembly is movable.
3. Lift the tubing holder straight away from the pump face.
4. To load the tubing, begin to lay the tubing in the pump channel, with both ends on the righthand side.
5. Manually turn the tri-star shaped head to turn the rollers as needed so you can insert the tubing against the occlusion wall.
6. When the tubing is in place, reinstall the tubing holder, with the cutout on each end cupping the tubing. Make sure to align the groove in the tubing holder end blocks with the key ridge on the pump face.
7. Finger tighten the turnbuckle rod between the ends of the tubing holder until the tubing is securely held in place, top and bottom.
8. Hold the safety cover in place as you reinstall all 4 thumbscrews. Finger tighten the thumbscrews.



CAUTION: NEVER RUN THE PUMP WITHOUT THE SAFETY COVER IN PLACE.

3.3 Installing the Pump

Place the pump on a stable, even surface, and position it so the pump head and controls are easily accessible to the user.



CAUTION: AFTER THE TUBING IS LOADED BUT BEFORE THE PUMP IS PRIMED OR RUN, REST THE PUMP SQUARELY ON ITS 4 RUBBER FEET, TO PREVENT LIQUID DRIPPING INTO THE PUMP HEAD OR ONTO THE CONTROLS.

Once the pump has been primed, if desired, you can rotate the handle underneath the pump to serve as a base. If needed, tighten the screws that hold the handle to the pump body, so the handle will not slip from the designated position.

4. SPECIFICATIONS

	TPU Variable Speed	TPU Fixed Speed	TPV Variable Speed
Rollers, quantity	4 Standard 10 Optional	4 Standard 10 Optional	3 Standard
Material	316 Stainless steel	316 Stainless steel	316 Stainless steel
Maximum Lift, Pump Head	340 in H ₂ O (12.3 psig)	340 in H ₂ O (12.3 psig)	310 in H ₂ O (11.2 psig)
Maximum Suction, Pump Head	350 in H ₂ O (12.6 psig)	350 in H ₂ O (12.6 psig)	310 in H ₂ O (11.2 psig)
Pumping Speeds	0 - 60 rpm	Preset to 3, 10, 20, 30, 40 or 50 rpm	0 - 300 rpm
Motor	Brushless DC	AC Shaded Pole	Brushless DC
Power Supply*	Power cord & plug	Power cord & plug	Power cord & plug
Electrical Requirement	110-250 V	110-250 V	110-250 V
Fuses	Two 2-Amp, 250 V, fast-acting, glass, 5 x 20 mm, UL-listed		
Reversible flow	Yes	No	Yes
Priming function	Yes	No	Yes
Timing function	Optional	No	Optional

*Specific power cords & plugs available for North America, Europe, UK, and Australia

DIMENSIONS	TPU FX, AD, DP & RP	TPV AD, DP & RP
without handle	6.5 in W x 5.67 in D x 4.12 in H (16.5 cm W x 14.4 cm D x 10.5 cm H)	7.7 in W x 7.45 in D x 6.56 in H (19.6 cm W x 18.9 cm D x 16.7 cm H)
	TPU₁	TPU₂
pump head alone	6.5 in W x 1.23 in D x 4.12 in H (16.5 cm W x 3.1 cm D x 10.5 cm H)	6.5 in W x 1.23 in D x 4.12 in H (16.5 cm W x 3.1 cm D x 10.5 cm H)

5. OPERATING INSTRUCTIONS

5.1 Powering On

1. After you verify that your power cord plug is suitable for your electrical supply, connect the cord to the back of the pump case, then plug it into your power outlet.
2. On the back of the pump, turn the on/off power switch ON.
3. If your pump has a Run/Brake switch, turning the switch to Run will turn the pump on.

5.2 Priming the Pump

With one end of the tubing in the liquid you need to pump, and the other end in the target receptacle or appropriately clamped to the target site:

- *If your pump has a Prime button, press and hold the button at Maximum Speed for a few seconds, until the liquid is successfully suctioned into the tubing.*
- *If your pump does not have a Prime button, turn the pump On (main power switch on back). The amount of time it will take for the pump to prime depends on the preset pump speed.*

5.3 Programming the TPUDP MUR3 Timer (if present)

The timer relay on this pump model can be set to two modes of operation, as explained with reference to Figures 6 & 7.

FIGURE 6: LOCATION OF MUR3 TIMER CONTROLS



1	See Figure 7 for a closer look
---	--------------------------------

FIGURE 7: MUR3 TIMER CONTROLS

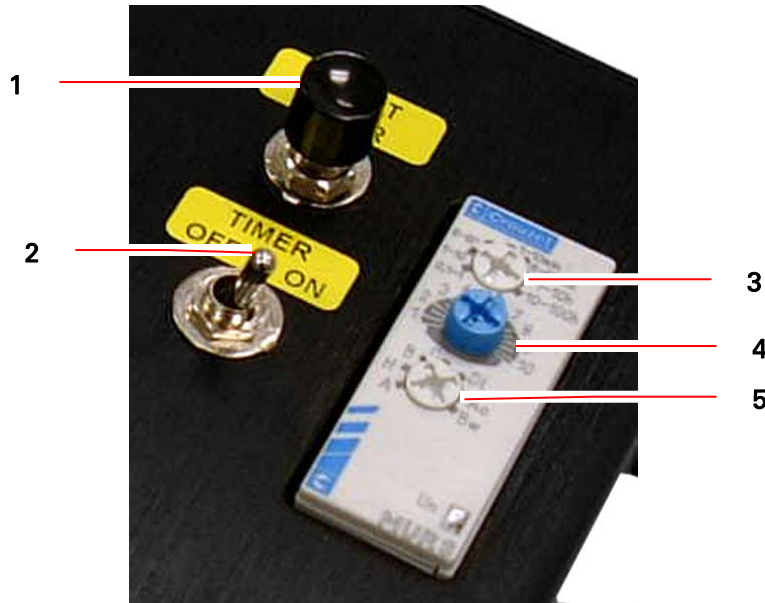

1	Start Timer button	4	Multiplication knob
2	Timer ON/OFF switch	5	Relay timer Mode switch
3	Time Period knob		

▪ *Single Shot Mode*

1. Using an appropriate flathead screwdriver, dial the Time Period (white) knob to the desired position, then dial the Multiplication (blue) knob to the desired position.
2. To run once for the programmed time period, set the relay timer MUR3 Mode switch to **B**.
3. Activate the timed program manually by pressing the pump's Start Timer button, or activate it remotely via the 9-pin connector on the pump's rear panel.



NOTE: For TPUDP pumps, a Remote Start option is available using the 9-pin female D-connector located on the rear panel, via pins 1 and 5.

- *Continuous Pulse Mode*

1. Using an appropriate flathead screwdriver, dial the Time Period (white) knob to the desired position, then dial the Multiplication (blue) knob to the desired position.
2. To run a preset continuous program of a specified run time (ON) followed by the same length of OFF time, set the relay timer MUR3 Mode switch to **Di**.

Remember that you can also set the pumping speed, which will control the amount dispensed during the ON period.

NOTE: Any time you change the TPUDP pump's MUR3 timer Mode, the new setting will be activated only after cycling Timer's On/Off switch. We recommend therefore that you change timer Mode settings when the timer switch set to the Off position. This way, when the timer On/Off switch set back to the On position, the new settings will be activated.

5.4 Programming the TPURP MLR1 Timer (if present)

The TPURP timer relay can be set to dispense liquid over a chosen time period, and to stop dispensing for another chosen time period. With reference to Figure 8, use the top set of knobs on the MLR1 timer relay for setting up the dispensing ON mode, and use the bottom set for setting up the non-dispensing OFF mode.

FIGURE 8: MLR1 TIMER CONTROLS
(shown uninstalled)

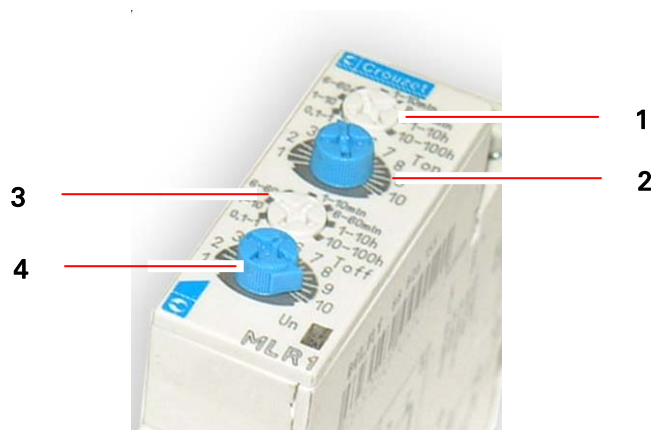

1	ON Time Period knob	3	OFF Time period knob
2	ON Multiplication knob	4	OFF Multiplication knob

The pump can be set to dispense ON and OFF for any of the following 7 time periods:

1. 0.1 – 1 sec
2. 1 – 10 sec
3. 6 – 60 sec
4. 1 – 10 min
5. 6 – 60 min
6. 1 – 10 hr
7. 10 – 100 hr

Using an appropriate flathead screwdriver, dial the Time Period (white) knob to the desired position, then dial the Multiplication (blue) knob to the desired position. *For example, you want your pump to be ON (dispensing) for 24 minutes, and then to be OFF (not dispensing) for 3 hours:*

1. Set the top (ON) Time Period knob to the 6 - 60 min range, then dial the top Multiplication knob to the number 4. $6 \times 4 = 24$ minutes.
2. Set the bottom (OFF) Time Period knob to the 1 - 10 hr range, then dial the bottom Multiplication knob to the number 3. $1 \times 3 = 3$ hours .

NOTE: For TPURP pumps. the Start Timer button and  Remote Start option (using the 9-pin female D-connector located on the rear panel) are not supported.

6. MAINTENANCE

- Routinely check the tubing for wear and/or leaks. Replace as needed.
- Routinely clean the outside of the pump with a damp cloth, then wipe it with a dry cloth.

7. TROUBLESHOOTING

Symptom	Possible Solution
Pump does not power on.	Make sure the power cord is properly connected between the back of pump and the power outlet.
	One or both of the fuses needs to be replaced.
	Liquid may have leaked into the pump head: with the power OFF, clean the pump head with a moist cloth, then dry it. If it still does not run, call for service.
Pump does not produce the expected flow.	Tubing may be loose around the pump head; remove, then reinstall it tightly.

8. STORAGE

If you need to store your equipment, we advise you to pack it for safety in the original shipping carton.

9. RETURN

If you need to return your pump (or pump component) for repair, please contact the customer service representative at your Aalborg[®] distributor or, if you purchased the item directly, contact the customer service representative at Aalborg[®]. Be sure to request a Return Authorization Number (RAN).



NOTE: Equipment returned without a RAN will not be accepted.

We advise you to pack the equipment for safety in its original shipping carton.

You are responsible for return shipping charges. Collect shipments will be refused.



CAUTION: ANY EQUIPMENT RETURNED FOR REPAIR MUST BE COMPLETELY CLEANED OF ANY



DANGEROUS MATERIAL, INCLUDING BUT NOT



LIMITED TO TOXIC, BACTERIALLY INFECTIOUS, CORROSIVE OR RADIOACTIVE SUBSTANCES.

ALL EQUIPMENT RETURNED MUST INCLUDE A FULLY EXECUTED, SIGNED AND DATED SAFETY CERTIFICATE, AVAILABLE FROM YOUR AALBORG[®] SERVICE MANAGER.

Aalborg[®] reserves the right to charge you a fee for equipment returned under warranty if the instrument is determined to be free of defects covered by warranty.

10. ABBREVIATIONS

The following abbreviations are used in this manual:

AC	Alternating Current
cm	Centimeters
D	Deep
DC	Direct Current
H	High
Hg	Mercury
H ₂ O	Water
hr	Hours
in	Inches
min	Minutes
OEM	Original Equipment Manufacturer
RAN	Return Authorization Number
rpm	Revolutions per minute
sec	Seconds
V	Volts
W	Wide

Астана +7(77172)727-132 Волгоград (844)278-03-48 Воронеж (473)204-51-73
Екатеринбург (343)384-55-89 Казань (843)206-01-48 Краснодар (861)203-40-90
Красноярск (391)204-63-61 Москва (495)268-04-70 Нижний Новгород (831)429-08-12
Новосибирск (383)227-86-73 Ростов-на-Дону (863)308-18-15 Самара (846)206-03-16
Санкт-Петербург (812)309-46-40 Саратов (845)249-38-78 Уфа (347)229-48-12
Единый адрес: alg@nt-rt.ru Веб-сайт: aalborg.nt-rt.ru

11. WARRANTY

Aalborg[®] TPU and TPV Pumps, Pump Heads & Pump Motors are warranted against defects in parts and workmanship for a period of one year from the date of purchase.

If tubing used with is not recommended by Aalborg[®], this warranty may be void.

If the instrument is used to pump liquids specifically not recommended by Aalborg[®], this warranty may be void.

Defective products will be repaired or replaced solely at the discretion of Aalborg[®] at no charge. Shipping charges are the responsibility of the customer.

This warranty is void if the equipment is found to be damaged by misuse, accident, or has been repaired or modified by anyone other than Aalborg[®] or a factory-authorized service facility.

This warranty defines the obligation of Aalborg[®] and no other warranties expressed or implied will be recognized.



NOTE: See Section 9 for proper Return procedures.